

RECTIFIERS

Military Approved, High Efficiency,
2.5 Amp and 6.0 Amp

1N5802, 1N5804, 1N5806,
1N5807, 1N5809, 1N5811
JAN, JANTX & JANTXV

FEATURES

- Qualified to MIL-S-19500/477
- PIV: to 150V
- Low Forward Voltage

DESCRIPTION

This series of high efficiency power rectifiers are particularly applicable to switching regulator power supplies where extremely fast switching and low forward losses are most important.

ABSOLUTE MAXIMUM RATINGS

Peak Inverse Voltage	2.5A Series	6A Series
50V	JAN, JANTX & JANTXV 1N5802	JAN, JANTX & JANTXV 1N5807
100V	JAN, JANTX & JANTXV 1N5804	JAN, JANTX & JANTXV 1N5809
150V	JAN, JANTX & JANTXV 1N5806	JAN, JANTX & JANTXV 1N5811

	2.5A SERIES	6A SERIES
Maximum Average D.C. Output Current		
@ $T_A = 75^\circ\text{C}$, $L = 3/8"$	2.5A	6.0A
@ $T_A = 55^\circ\text{C}$	1.0A	3.0A
Non-Repetitive Sinusoidal		
Surge Current (8.3ms)	35A	125A
Operating Temperature Range	-65°C to +175°C	
Storage Temperature Range	-65°C to +200°C	
Thermal Resistance, θ_{JL} @ $L = 3/8"$	59°C/W	35.5°C/W

See lead temperature derating curve

MECHANICAL SPECIFICATIONS

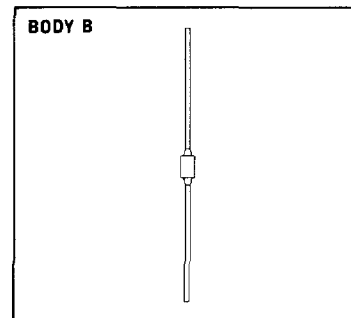
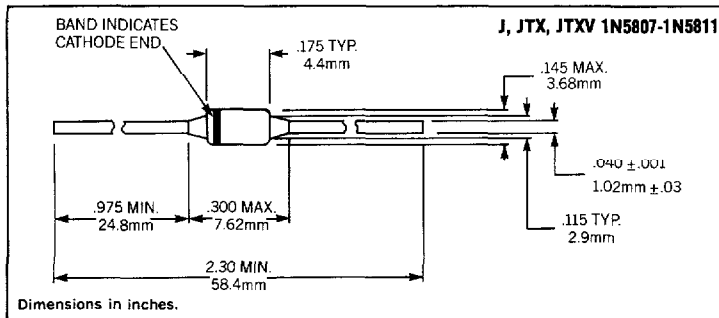
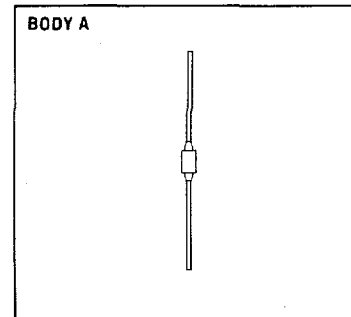
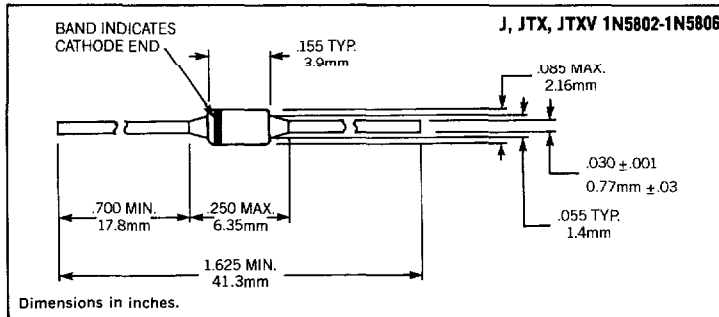

THESE DEVICES ALSO AVAILABLE IN SURFACE MOUNT PACKAGE. SEE SECTION 10

ELECTRICAL SPECIFICATIONS (at 25°C unless noted)

2

Type	PIV	Minimum Breakdown Voltage @ 100µA	Forward Voltage		Maximum Reverse Current @ PIV		Maximum Reverse Recovery Time
			@ 25°C	@ 100°C	25°C	100°C	
J, JTX, JTXV 1N5807	50V	60V	.875V Max. @ 4A (pk)	.8V Max. @ 4A (pk)	5µA	150µA	30ns $I_F = I_R = 1.0A$ $I_{REC} = 0.1A$ $di/dt = 100A/\mu s$ min.
J, JTX, JTXV 1N5809	100V	110V	.925V Max. @ 6A (pk)				
J, JTX, JTXV 1N5811	150V	160V					
J, JTX, JTXV 1N5802	50V	60V	.875V Max. @ 1A (pk)	.8V Max. @ 1A (pk)	1µA	50µA	25ns $I_F = I_R = 0.5A$ $I_{REC} = 0.05A$ $di/dt = 65A/\mu s$ min.
J, JTX, JTXV 1N5804	100V	110V	.975V Max. @ 2.5A (pk)				
J, JTX, JTXV 1N5806	150V	160V					

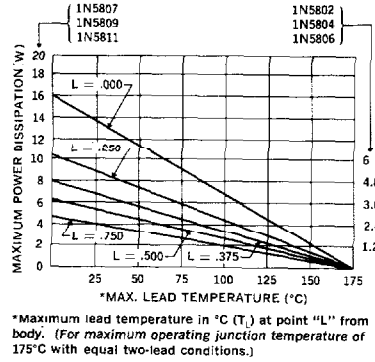
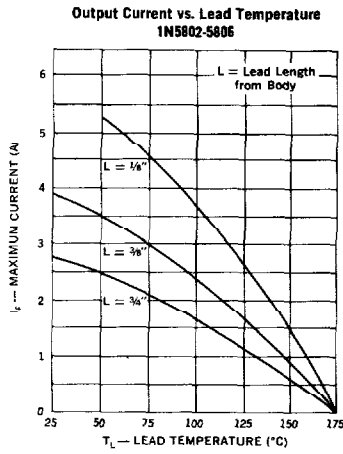
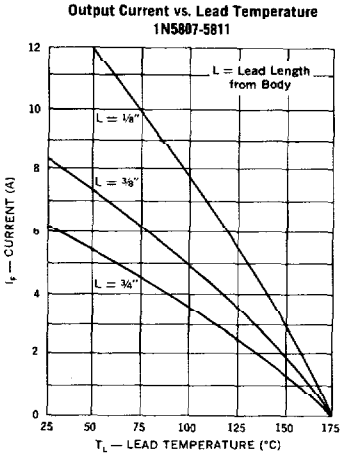

Reverse-Recovery Circuit

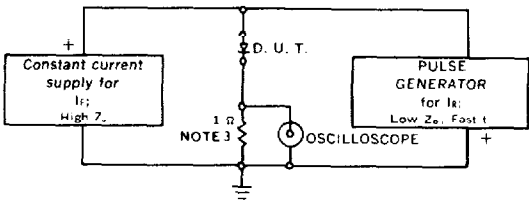

- NOTES:
- Oscilloscope: Rise time $\leq 3ns$; input impedance = 50Ω.
 - Pulse Generator: Rise time $\leq 8ns$; source impedance 10Ω.
 - Current viewing resistor, non-inductive, coaxial recommended.

Characteristic Waveform

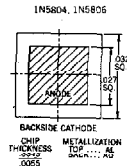
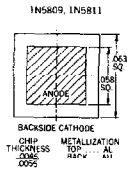
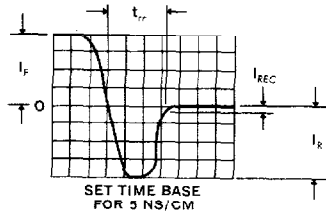

Typical Forward Current vs. Forward Voltage
JAN & JANTX 1N5807-5811

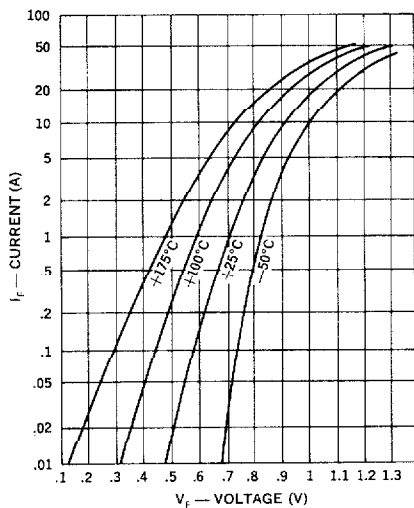

Typical Reverse Current vs. Voltage
JAN & JANTX 1N5807-5811

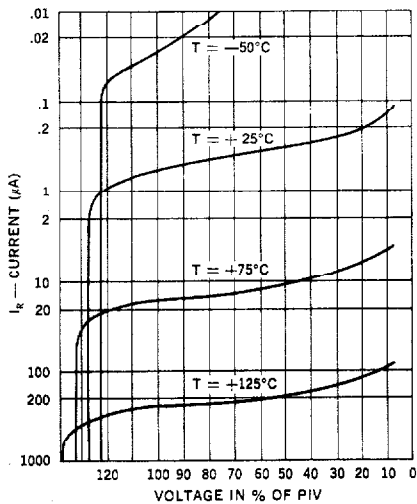

Typical Forward Current vs. Forward Voltage
JAN & JANTX 1N5802-5806

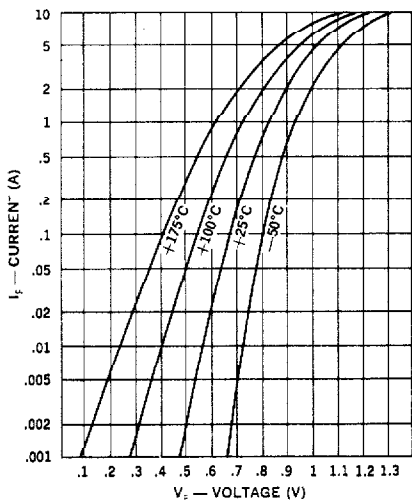

Typical Reverse Current vs. Voltage
JAN & JANTX 1N5802-5806

